

IRONBOURNE

LONG DISTANCE TRIATHLON

SUNDAY 9th JULY 2023



MIDDLE DISTANCE ATHLETE GUIDE



PERMITTED EVENT
ORGANISER 2023



MACMILLAN
CANCER SUPPORT

Choice
VEHICLE RENTALS



EASTBOURNE
COLLEGE



Welcome to IronBourne

We are very excited to be welcoming you to Eastbourne for the third edition of the IronBourne Long Distance Triathlon.

Please note, **this guide is for the middle-distance** triathlon, middle-distance aquabike, and middle-distance relay. If you are competing in the full-distance races or the marathon, please visit www.140.6miles.co.uk and download the separate athlete guides.

You must read the information provided in this guide carefully. It covers everything you need to know including very important information relating to directions on the bike and run which you must read and understand before the race. For those who raced here last year, please note there are improvements to the run route. **This guide contains everything you need to know and there will be no face-to-face briefing at the event.** Race director Mat Dowle will be around the finish area on Saturday afternoon to answer any questions you may have that are not covered in this guide.

Please note, during the week leading up to the event we will be on site setting up and we will not be able to respond to emails. For any last-minute queries, please visit the help desk on Saturday.

We are always in need of volunteers. If you have friends or family who can help, please email volunteers@tribourne.co.uk.

Following the race, your feedback is always very important for us. We can't wait to hear all about your day and hope you will share your race day experience with us.

We wish you the very best of luck with your remaining days of training and of course on race day.

Mat Dowle and Dale Anderton
TriBourne Multisport Events Ltd.

IMPORTANT

**There will be no race briefing on the day.
It is compulsory to read this briefing
document before the race.**

Schedule

Saturday 8th July

13:00 Registration and transition open
18:00 Registration and transition closed

Sunday 9th July

04:30 Transition open
05:30 Transition closed
05:50 Long-Distance start (self-seeded rolling start)
06:00 Middle-Distance start (self-seeded rolling start)
06:20 First Middle-Distance Swim finisher
06:40 First Long-Distance Swim finisher
07:30 Last Middle-Distance Swim finisher
08:20 Last Long-Distance Swim finisher (2hr 20 cut-off)
08:30 First Middle-Distance Bike finisher
09:45 First Middle-Distance finisher
11:00 Transition opens to Middle-Distance competitors for bike collection
11:00 First Long-Distance Bike finisher
11:40 Last Middle-Distance Bike finisher
12:00 Marathon start
14:00 First Long-Distance finisher
14:40 Last Middle-Distance finisher
15:00 Transition opens to all competitors for bike collection
16:30 Last Long-Distance Bike finisher (10hr 30 total time cut-off)
21:45 Final run lap cut-off
23:00 Last Long-Distance Finisher (17hr total time cut-off)

BRIGHTON & HOVE TRIATHLON

10th SEPTEMBER 2023



PERMITTED EVENT
ORGANISER 2023



Location

The event takes place at the **Western Lawns, Eastbourne, BN21 4EH.**



Parking

There is no specific parking location for the event, but there is plenty of on-street parking on the roads in the area. The map below shows the nearby roads where on street parking is free of charge (highlighted in yellow). You may need to walk around 1km so plan to arrive early to give yourself time to find a parking space and walk from your car to the race venue at the Western Lawns.



Accommodation

There are numerous hotels in Eastbourne, many located close to the race venue. The Lansdowne hotel is situated directly next to the event and are offering participants a 15% discount.

Please use this link to book:

<https://be.synxis.com/?adult=2&chain=5301&hotel=41083&locale=en-GB&adult=2&coupon=IRON15>

The Lansdowne has the following available:

- Storage for bikes
- Menu for participants (Pasta, etc)
- Flexible breakfast times
- Sunday Brunch / lunch

Site Map



Spectators

IronBourne is a great event for spectators, and we would like to encourage you to bring your friends and family to watch you race. The location next to the beach is great for the whole family. This year the event will be bigger and better than ever featuring a full event village with a bar, food, ice-cream and various other vendors and stalls.

Once the swim has finished there is a great walk up onto the downs where you can watch the cyclist coming up over Beachy Head. There are many great cafes along the seafront where you can watch the run.

Live Results

Live results will be available throughout the day via our website www.140.6miles.co.uk.



Choice
VEHICLE RENTALS

OFFICIAL TRIBOURNE VEHICLE PARTNER



Choice have been a massive supporter of our events, and we would like to ask you to support them in return. If you need to hire a vehicle please consider using Choice Vehicle Rentals just quote code tribourne to receive your 15% discount.

ENDLESS HORIZONS ENDLESS OPPORTUNITIES



Find out more and enquire online
www.eastbourne-college.co.uk

Registration and Racking

Registration and bike racking will take place on Saturday 8th July between 1pm and 6pm on the Western Lawns (next to the big wheel).

Registration

Once you arrive at the registration desk, **please give your last name** and we will check your details. You will then be issued with a race pack containing a numbered wrist band. This must be worn throughout the event and must not be removed until after you have collected your bike from transition at the end of the event. Each wrist band has your race number which will be used to identify you in case of a medical emergency and to collect your kit from transition after the race.

If you are a BTF member you will be asked to show your BTF licence at registration. Since the BTF moved to electronic licences you must sign into your BTF account to access your licence. Please do this before arriving at registration to avoid delays. **We suggest taking a screenshot of the licence on your phone or printing a paper copy so you can access it quickly at registration.**

If you are **not** a BTF member you will have purchased a day-licence when you signed up for the event. You will be emailed a copy of this a few days before the event for your information only, but there is no need to bring this to the event.

Once you have received your race pack, please put on your wrist band straight away.

You will then collect your timing chip. As you pass various timing points on the course, this will record your times for each leg of the race. You must wear your timing chip around your **left ankle**. We advise you to make sure it is attached securely. Please be aware that no timing chip, or incorrect use of the chip will mean you will not appear in the results. If you have any timing queries after race day, please email us. The timing chip is your responsibility until you hand it back at the finish. Due to the costs of the timing technology, there will be a £40 charge if you fail to return your timing chip. **You will be issued your timing chip on Saturday, so don't forget it on Sunday morning!**

Your race pack will contain all the essential items for your race. Please take the time to go through it all carefully. It will contain the following:

- **Number sticker sheet** - This will include a helmet number sticker (which must be stuck to the front of your helmet before you check your bike into transition) and a long bike number sticker which you must stick around your seat post so that the number is clearly visible from both sides. These stickers should not be taken off until you remove your bike from transition after the

race. For security, the bike number and your wrist band must match for you to remove your bike from transition after the event.

- **Two race numbers** - Your race number must be on your back during the cycle and on the front during the run. You can either use a single number attached to an elastic number belt or you can fix one number on your front and the other to your back. Most people will use a race belt but if you wish to pin on your numbers, please bring your own safety pins. Remember, you **must wear your race number on your back during the bike and on your front during the run**, so don't forget to spin your race belt around in T2 if you choose to use one.
- **Swim cap** - During the swim, you must wear the swim cap provided. The colour of the swim cap will identify your starting wave:
Full-distance races (including 3.8km swim): **Green**
Middle-distance races: **Pink**

Race T-shirts

Middle distance competitors will receive a race t-shirt and full distance competitors will get a hoodie. You will collect your t-shirt after you finish the race by handing in your timing chip. We will also have additional hoodies and t-shirts available at the TriBourne Shop throughout the weekend.



Racking

Once you have registered, you should make your way towards transition. Before reaching transition check-in you should attach your bike sticker to your seat post and your helmet number to the front of your helmet. Your helmet should be on your head and fastened during bike check-in. You will enter transition via the bike-check gate situated next to the TriBourne Star Tent.

You must bring your helmet with you to bike check-in on Saturday afternoon.

Transition is a secure area, and you will only be allowed to enter if:

- You are wearing your numbered **wrist band**.
- **Your helmet is fastened** on your head before you pass through the bike check-in. This must be an approved cycling helmet of ANSI Z90.4, SNELLB90, EN 1078 or an equivalent national standard. (NOTE: a CE mark is NOT an approval mark). NB: any helmet bought in recent years will comply but check for damage which would stop it protecting you properly. Your helmet should be correctly adjusted to fit correctly. Please see <https://www.youtube.com/watch?v=lyhyrITHDgw> for tips.
- **Your Bike is safe**. It is your responsibility to bring a bike that is road worthy and complies with the BTF rules (visit www.britishtriathlon.org for more information). Your handlebars must not have open metal ends so please obtain bar ends to plug them before coming to the race. Fixed wheel bikes (bikes that use the pedals as a brake) are not permitted in the race and e-bikes are also not permitted.
- **Your numbered bike sticker** is attached to your bike seat post.

You must not use headphones, mobile phones or any other such devices in transition as this could be considered a distraction.



Racking is numbered with odd numbers on one side and even numbers on the other. For fairness, age-groups will be grouped together in transition, however, please note those signing up in the final two weeks before the race may not be racked with others from their age-group.

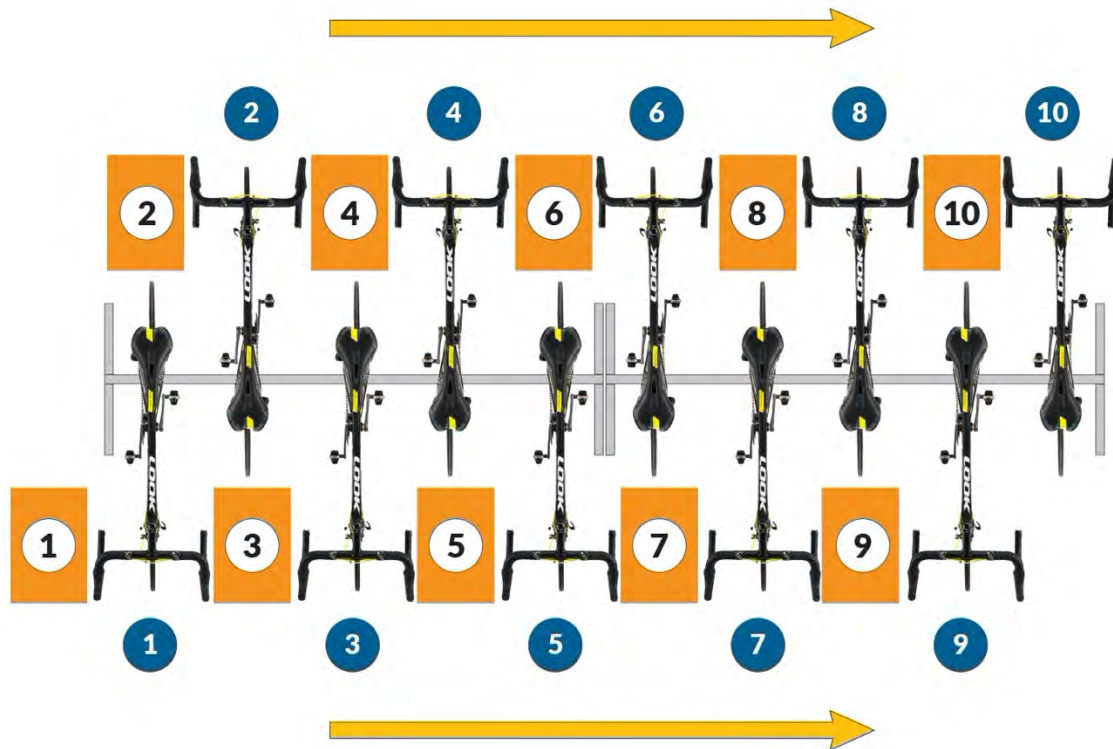

Each numbered space in transition will have one box (measuring 60cm long x 40cm wide x 15cm high). **As you follow the flow through transition (away from the beach) your box will be the one immediately before your bike position (on the seaward side of your bike).** You must place all your kit in the box. We will be operating a clean transition area which means nothing should be left outside your designated box except for your running shoes (which can be placed neatly in front of your box) and anything attached to your bike (nutrition, etc.).

Transition will close at 6pm on Saturday. You will be able to access transition for final preparations on race morning between 4:30am and 5:30am.

QUIET PLEASE

Please keep very quiet on Sunday morning. There are many residents in the area who don't want to be woken early in the morning and any disturbance early on race morning could jeopardise the future of the event.

Baggage Area

Where possible, please place all your baggage in your numbered box in transition. There will also be an area within the transition area where you can leave oversized bags. **This will be located at the far end of transition next to row 10.** Please note this area will not be covered; it is within the secure transition area, but you will leave your bags in this area at your own risk.

Sunday Morning

On Sunday morning, having checked your bike and made use of the toilets at the Western Lawns, please make your way to the pier. **The start is a 1km walk from the transition area, so please leave plenty of time to walk to the start.**

If you wish to get in the water before the start, please do so. The beach just before the pier will be used as a warm-up and staging area. **If you choose to have a swim warmup, please ensure you are out of the water and ready to move onto the pier 15 minutes before the start (5:35 for long distance and 5:45 for middle distance).**

There should be no need to wear shoes to the start, however if you choose to wear an old pair of shoes to the start, they can be disposed of in the sacks provided. These will be returned to the Western Lawns oversize baggage area; however, we cannot guarantee be able to return them to you after the race.



KIT SALE

255 TRIATHLON
THE WORLD'S LONGEST SINGLE-DAY TRIATHLON

ZONE3 50
BRIGHTON & HOVE
TRIATHLON

IRONBOURNE
LONG DISTANCE TRIATHLON

Any 10 items for £30
Saturday 1pm to 6pm at Registration

Start Procedure

Approximately 10 minutes before the start, we will call all athletes forward to the end of the pier.

The start will be a self-seeded continuous rolling 'time trial' start. Position yourself in the start queue based on your swim ability. Faster athletes should position themselves nearer the front and slower swimmers nearer the back. Elite athletes who will be racing for the overall podium places should aim to start first and position themselves at the front of the queue. With the rolling 'time trial' start there is nothing to be gained by starting further forward so don't rush to push to the front of the queue.

There will be a table next to the start on the pier where you can leave glasses. These will be taken to the swim exit and be available as you come off the beach.

Once the race starter indicates to the first athlete to start, all athletes will then continue moving forward. As you approach the jump you will enter the timing point area. The timing system will record your time as you leave the timing area **so your time will not start until you jump**. When it is your turn to start, listen to the start marshal who will ensure the previous athlete is clear before allowing you to jump. **Please jump feet first – NO DIVING.** Please proceed immediately when instructed to do so, so as not to hold up athletes behind you. If you are not ready to start immediately, you will be asked to step to one side until you are ready to jump. Once you are in the water, please start swimming immediately to allow the next person behind you to start.



Wetsuits

We will monitor the water temperature throughout race week. **On race day it is expected to be between 16°C and 18°C.** Please note wetsuits are **mandatory below 16°C and forbidden above 24.6°C.** For safety reasons, wetsuits are **recommended (up to the max temperature allowed) even if the temperature is above the mandatory lower limit**, as the wetsuit will not only keep you warm, but will also help you swim faster as it provides you with extra buoyancy. Surf and shortie wetsuits are allowed, but these are totally different to a triathlon specific wetsuit, which is designed for swimming. **The swim hats provided are compulsory.** You may not wear over-boots except if the use of wetsuits is mandatory. Please note the exit of the swim will be carpeted to protect your feet from the stones. Gloves are not permitted. We strongly advise you to practice swimming in your wetsuit before the event. Practicing getting out of the wetsuit will help with your transition on the day too.

Swim Safety

For many, the swim is the most daunting part of the race, but don't worry. Our water safety team will be there to guide you and help if required. The team, provided by First Aqua and the Eastbourne Voluntary Lifeguards, consists of fully qualified lifeguards in kayaks, SUP and rescue boats as well as additional lifeguards on the beach. All lifeguards are members of either the BCU Lifeguards or Surf Lifesaving GB. **If you do get into difficulty, lie on your back, and raise your arm; a lifeguard will come to you and if necessary, arrange a safety boat to take you to the water's edge.** Please do not use backstroke unless you have informed the organisers in advance as this can be easily confused with a swimmer indicating they are in difficulty.

ZONE3 

20% OFF

TRIBOURNE20



The Swim – Sponsored by Zone3

Once you have started you will swim directly out a short distance and make a right turn around the red buoy directly in front of the end of the pier. You will swim with the current parallel to the beach until you reach the next red turn buoy. **On your first lap only, turn towards the beach** (the current may pull you slightly to your left) **you are aiming to the beach to the right of the bandstand.**

As you approach the beach, make a right turn back towards the pier. You will be swimming against the current parallel to the beach. Continue under the pier between the two yellow swim buoys. Continue along the beach to the next red turn buoy where you will turn right. As you swim out the current will pull you to your right towards the end of the pier. Turn around the red buoy at the end of the pier. **You will now be following the first section of the route for a second time.** When you reach the second red turn buoy for the second time you continue straight ahead (sighting toward Beachy Head). Follow the yellow sighting buoys until you reach the final red turn buoy. Turn right and head in towards the finish.

As you make the final right turn back towards the beach, the current will be pulling you left. Aim to the right of the finish arch and allow the current to pull you left to the finish. If you allow yourself to be pulled too far to the left, you will find yourself battling against the current to get back to the finish.

Please note, full-distance competitors will be turning right on the beach to re-enter the water for their second lap. Do not follow them.

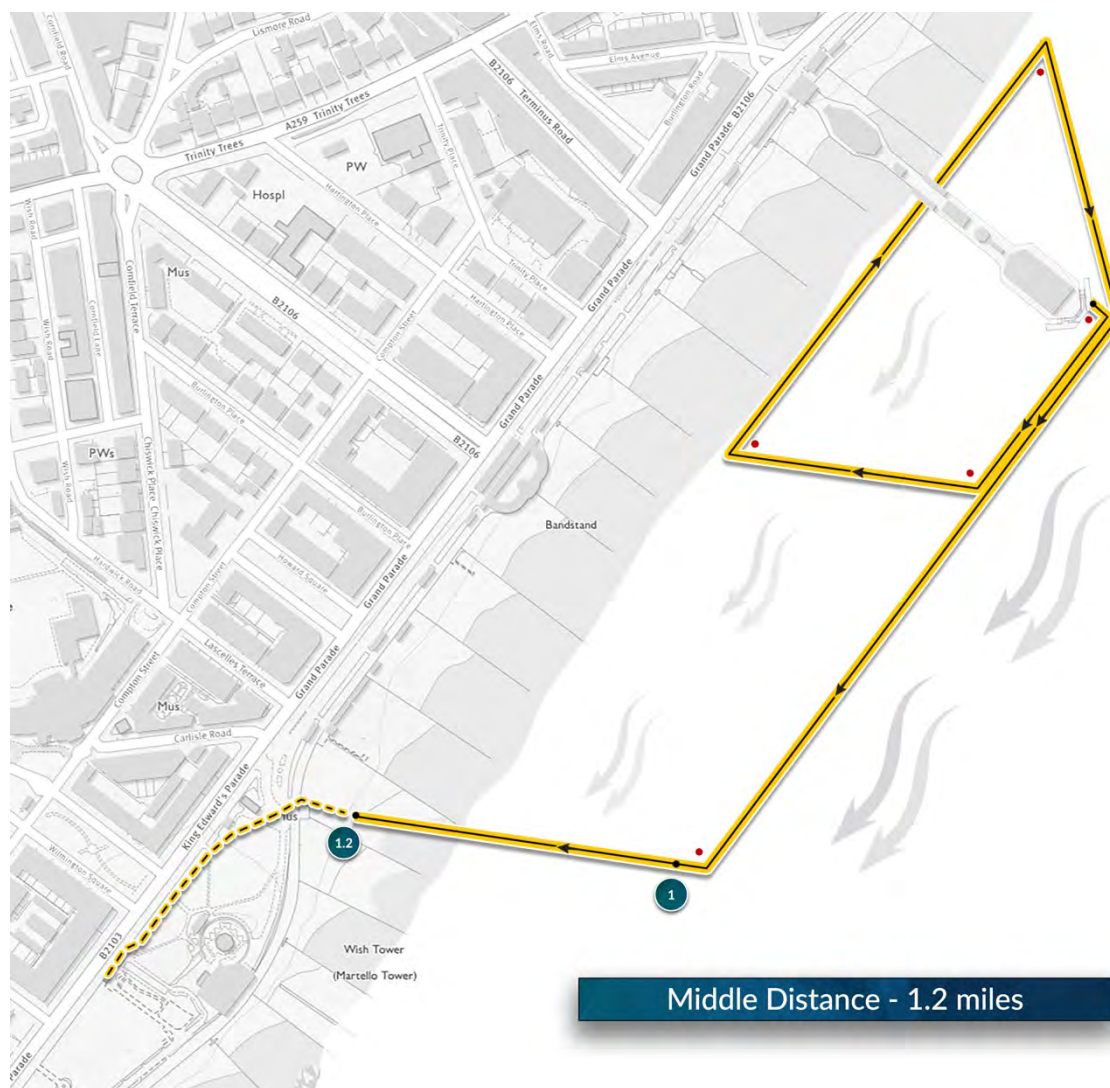

OUTGOING TIDE

From 1-2 hours before high tide until 1-2 hours before low tide

SWIMMING AGAINST THE CURRENT

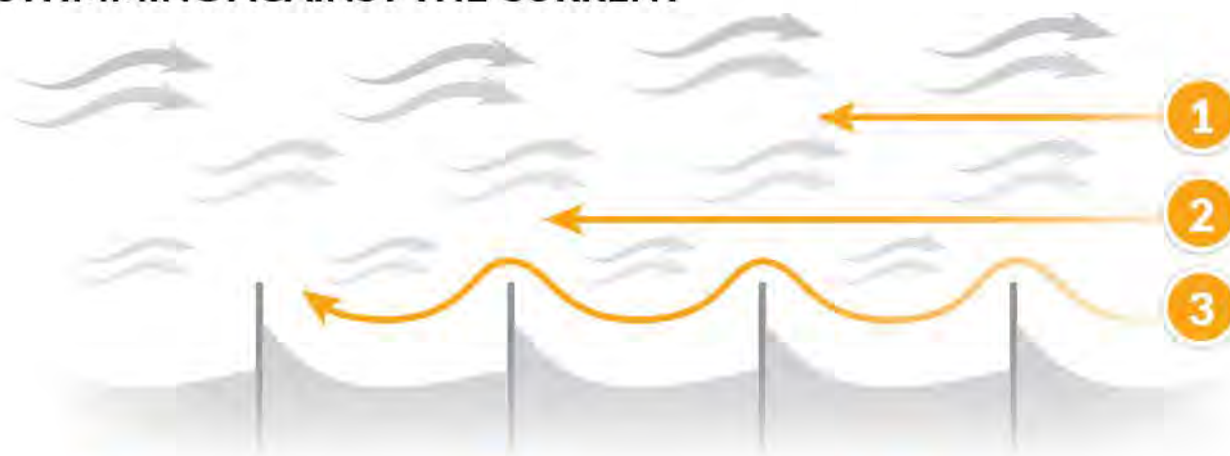

1

Currents get progressively stronger further from the shore. Avoid swimming too far out where the currents are strongest.

2

In most conditions swimming a straight line just beyond the groynes is the fastest option. *

3

When the current is extra strong you could consider sheltering between groynes. *

* Take care as groynes extend out below the surface.

SWIMMING ACROSS THE CURRENT

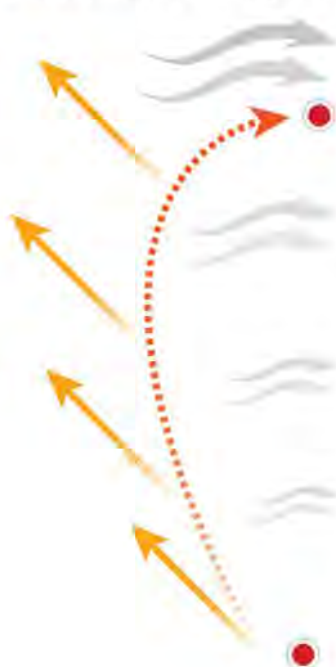

SWIMMING OUT

As you swim out, the current will pull you from left to right. Aim up to 45 degrees to the left of the target (yellow arrows). * Initially you will appear to be swimming too far to the left but as you get further out the current will get stronger and pull you back onto the turn buoy (orange dashed arrow).



SWIMMING BACK

As soon as you turn back towards the shore you should aim up to 45 degrees to the right of the target (yellow arrows). * Initially you will still be pulled a bit too far to the left (orange dashed arrow).

* The angle depends on the strength of the current and how strong you are as a swimmer:
Stronger swimmer and/or weaker current = smaller angle (15 - 30 degrees)
Weaker swimmer and/or stronger current = larger angle (30 - 45 degrees)



TRIBOURNE
MULTISPORT EVENTS
ZONE3

Swim Exit

Volunteers will be on hand to guide you out of the water. Once you have exited the water you will need to make your way on foot to the transition area which is 300m away on the Western Lawns. The beach will be carpeted and most of the run to transition is on grass. You may pull your wetsuit down to your waist as you make your way to transition, however, you may not remove your wetsuit completely until you reach your spot in transition.

Swim Cancellation

In the unlikely event the swim is cancelled, the race will start with the bike leg starting with a time-trial start from the bike mount line.



TRI
WETSUIT
HIRE

triwetsuithire.co.uk

TURBO
TRAINER
HIRE

turbotrainerhire.co.uk

BIKE
TRAILER
HIRE

kidsbiketrailers.co.uk

SNOW
CLOTHING
HIRE

snowclothinghire.co.uk

**Nationwide Outdoor Kit Hire.
Delivered To Your Door.**

If you don't want to commit to buying a wetsuit, our wetsuit hire partners Tri Wetsuit Hire and for those wanting to benefit from some indoor winter training, we can offer turbo, smart trainer and power meter hire available all with a 15% discount using code TriBourne15.

Transition 1: Swim to Bike

You will leave the beach and cross the lower prom onto the Wishtower Slopes. You will run uphill over the grass following a row of blue cones and enter the Western Lawns via the path at the northeast corner of the lawns. You will run across the front of the big wheel and enter transition at the southeast corner.

All routes are well marked but please make sure you familiarise yourself with the route from the swim exit to transition and through T1 when switching between disciplines, and especially note where you racked your bike. Getting lost in transition will add seconds to your finish time, which you have been training for months to reduce! You will run into transition to where your bike is racked.

There will be no changing tents in transition. If you need to change you should bring a changing robe.

Place your wetsuit and all other equipment entirely within your box. Failure to place everything completely in the box will result in a 15 second penalty.

You must put your helmet on and ensure it is done up before taking your bike. Only after your helmet is securely in place should you then take your bike and push it out of the transition area. You will push your bike across the zebra crossing to the mount point on the road.

Do not mount your bike until you have crossed the mount line.

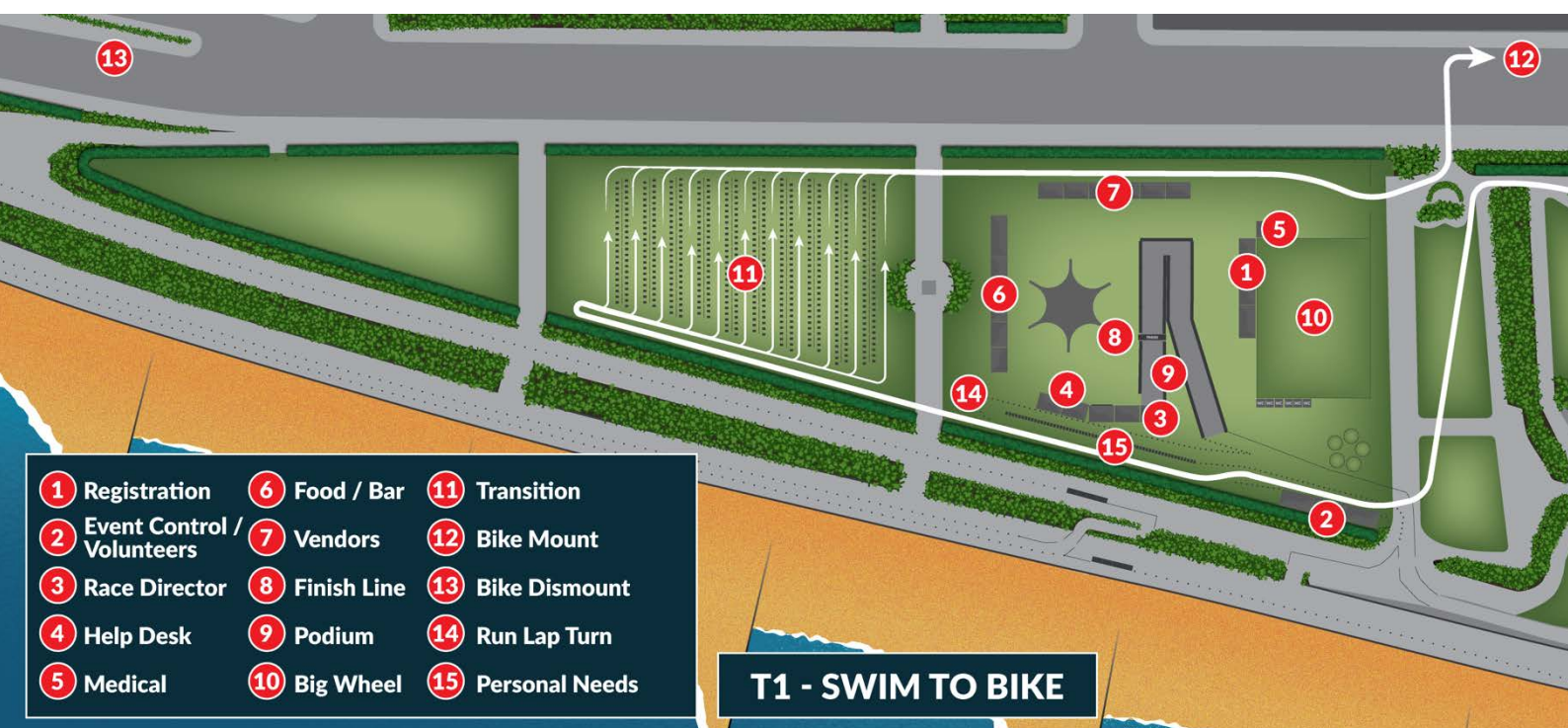

Clean Transition

You must ensure your wetsuit and all other swim kit is placed completely in your box in transition. **If your wetsuit is left outside your box, you will receive a 15 second time penalty.**

Relay Teams

You will be issued **ONE** bag at registration containing everything for the entire team. The first team member to arrive should collect the bag on behalf of the team. The bag will contain a single timing chip. This timing chip will act as your baton.

Relay exchanges will take place at your designated racking position in the transition area. Your timing chip is your 'baton' and must be exchanged between competitors.

Swim to Bike (T1) exchange: The cyclist must wait next to their bike in transition with their **helmet off**. The cyclist should be wearing their race number on their back and can have all cycling clothing on including shoes with the exception of their helmet. The swimmer must first hand over the timing chip which must be attached to the cyclist left ankle. Only when this is complete can the cyclist take their helmet and put it on before taking their bike and pushing it out of the transition area to the mount point on the road.

Bike to Run (T2) exchange: The runner will be waiting at the numbered racking point in transition. The incoming cyclist will dismount, enter transition, rack their bike and then remove their helmet. Only after this can the cyclist remove the timing chip and hand it to the runner to place on their ankle. The runner must wear the race number on their front.

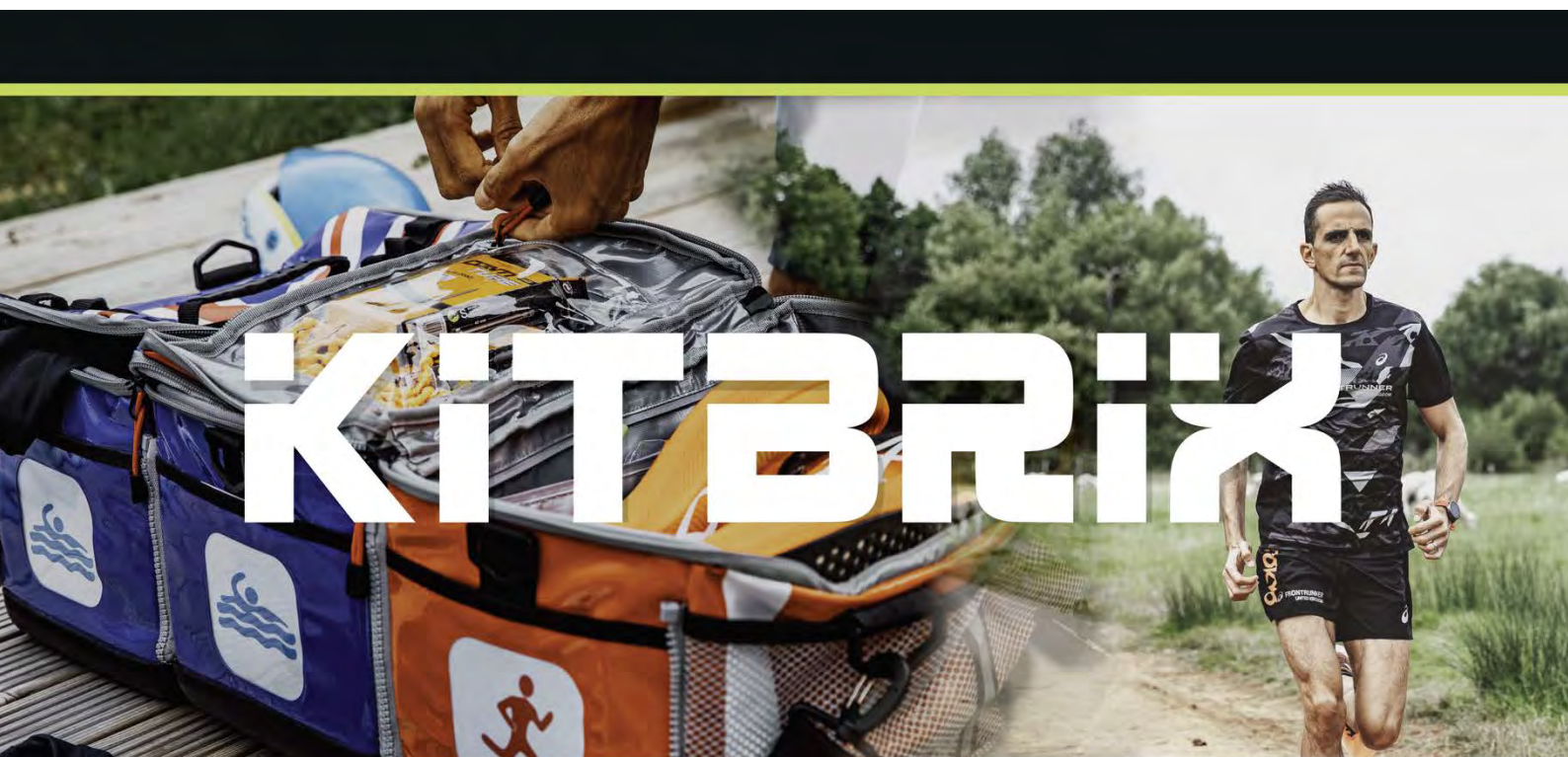

Bike Route Map

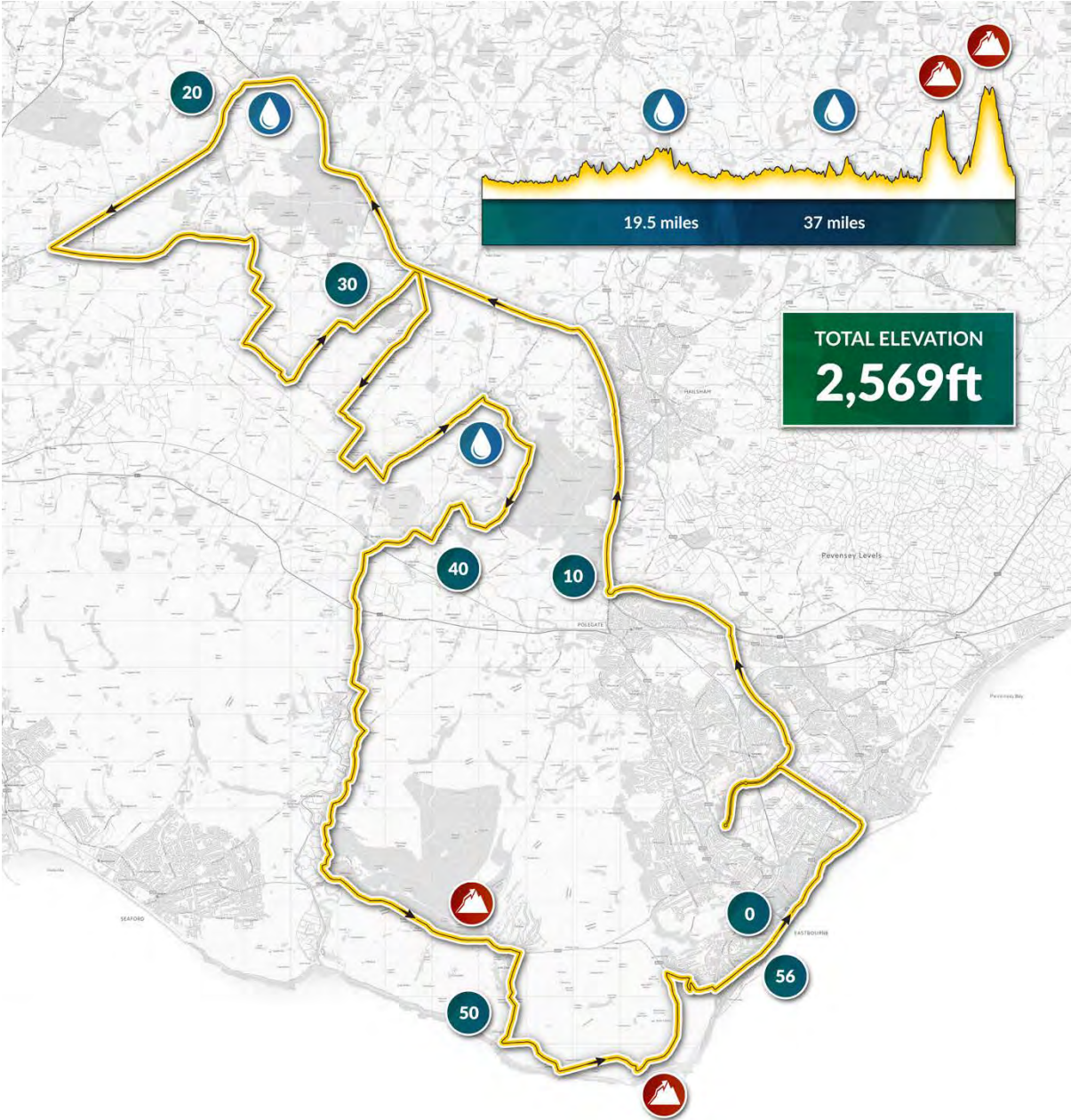

Bike Route

This section of the guide is detailed but is very important so please take your time to read it all.

IMPORTANT:

This event takes place on open roads. You must always follow the highway code. This includes giving way to pedestrians at zebra crossings, stopping at traffic lights and giving way at junctions and roundabouts.

Some of the route takes place on relatively busy A roads. This is not something to be concerned about. There will be plenty of signage warning motorists and several motorcycle and static marshals. Please take extra care when pulling out to overtake and signal your intent to do so to any vehicles overtaking you.

Please read the following pages carefully. They contain very important safety points.

Both the bike and run routes consist of various loops with middle and full distance competitors taking different options. In each case signs will explain which way to go on each lap with the distance marked. Full distance athletes follow the red sections (middle-distance will be following the green sections).

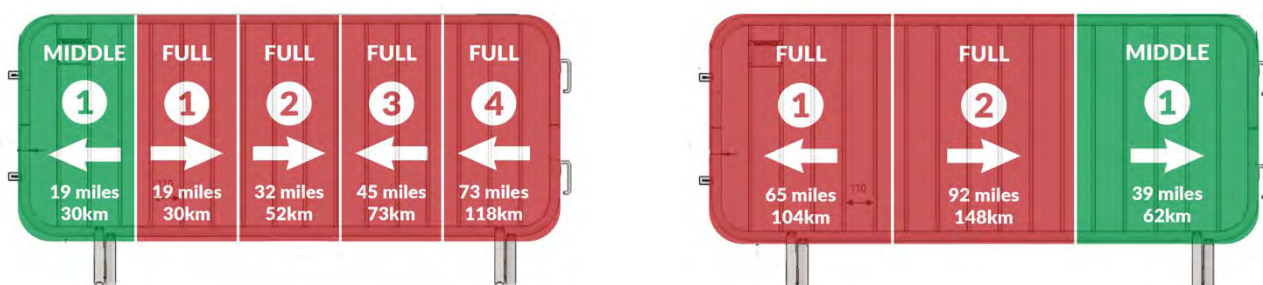

Section 1: Eastbourne to Halland

The first 30km (19 miles) is the same for both full and middle-distance competitors. You will first head east along the seafront before turning left at the first roundabout to head up Lottbridge Drive. In these first few miles you will pass 10 zebra crossings and 5 pelican crossings. Early on a Sunday morning you are very unlikely to get held up at any of these, however, you must stop and give way if pedestrians wish to cross. At the top of Lottbridge Drive you will turn left for an out and back section along Cross Levels Way; this is a great opportunity to see where the competition is.

You will make your way out of Eastbourne via dual carriageways and several roundabouts. **These roads will be very quiet at this time.**

Special attention should be given to the large roundabout at 15km/9.5 miles. You will be taking the 4th exit. As you go around the roundabout you will need to move across lanes to ensure you do not come off the roundabout too early. As you exit this roundabout please be aware of possible queuing traffic for the local car boot sale.



You will then follow the A22 (initially on dual carriageway and then single carriageway) all the way to the first aid station at Halland (30km/19 miles).

At this time on a Sunday morning traffic will be very light and we will have signs informing motorists how to safely overtake.

Halland Aid Station

As you turn off the main A22 into the aid station at Halland, be aware of the poor road surface in the layby. As you pass through the aid station you will pass the following:

1. Toilets
2. Empty bottle drop
3. Water (750ml bike bottles)
4. High 5 Energy Drink (750ml bike bottles)
5. High 5 Gels, and Bars
6. Litter / bottle drop
7. Personal needs bags (laid out in number order)

Course Split: Halland

IMPORTANT:

Immediately after the Halland aid station, the course splits. **Middle-distance competitors will turn left here**, however, please be aware that **full-distance competitors will turn right at this point**.



As you approach Ringmer you will make a very hard left turn at a mini roundabout back towards Laughton. **Take care on this tight turn.**

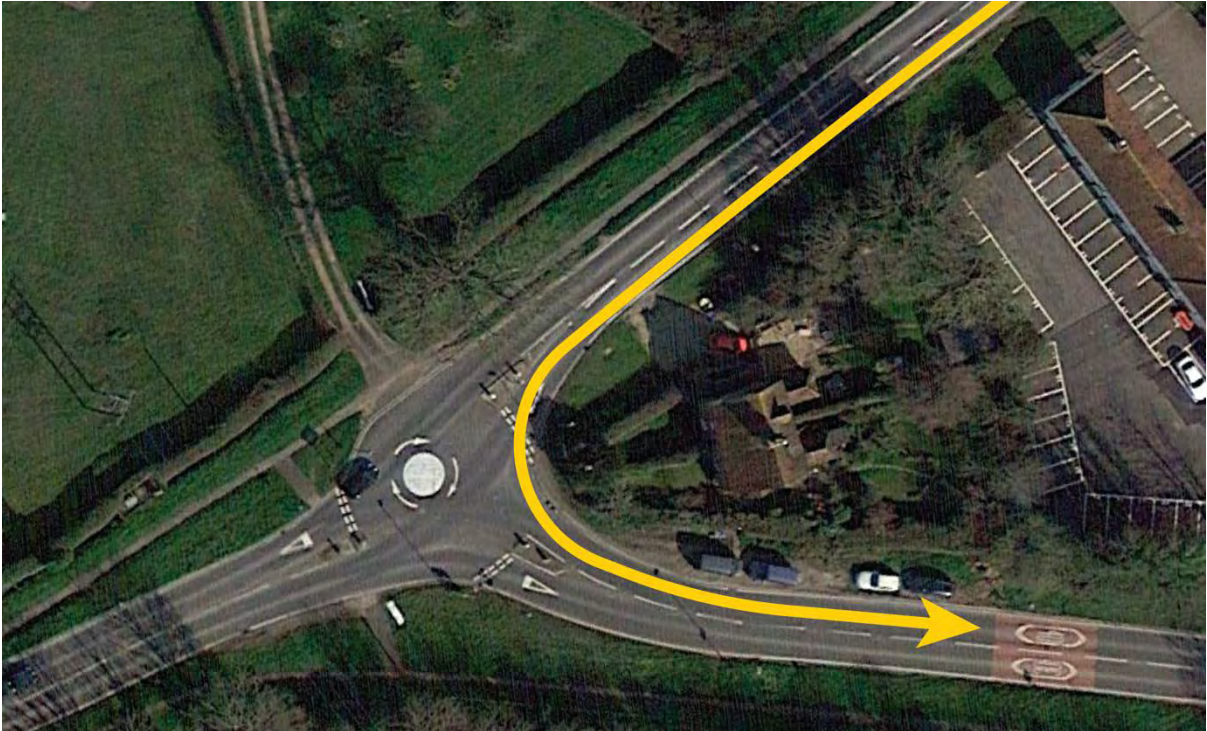

Just after Laughton you will make a right turn across oncoming traffic; take care and only turn when safe to do so (**marshals will NOT stop traffic**). You will then follow a series of narrow lanes through Ripe village and up to Golden Cross. The first narrow section of these lanes will be closed to traffic (except for some local residents), however on some sections you may encounter oncoming vehicles on the narrow roads so please take care when overtaking. On the road between Ripe and Golden Cross there is a short section of road which bends right and then left the under some trees which has several potholes. These will be marked with spray paint; please take care.

At Golden Cross you will turn right towards Chalvington. As you pass through Chalvington there is a tight, narrow, blind left bend. This will be marshalled; please take great care and pass through slowly in single file (no aerobars).

CAUTION - HORSE RIDERS:

In this area there are many stables, and it is not uncommon to come across horse riders on the road. We have informed all local stables, however if you do encounter a horse please pass slowly and with great care.

Past Chalvington you will make a left turn towards Upper Dicker. As you enter Upper Dicker you will make a right turn across oncoming traffic. You will then pass the second aid station which will be laid out in the same order as the first one. A few miles past this aid station the course once again splits.

Course Split: Arlington

At this point you make a right turn (following the green arrow). Please note, full distance athletes will continue straight ahead at this point.

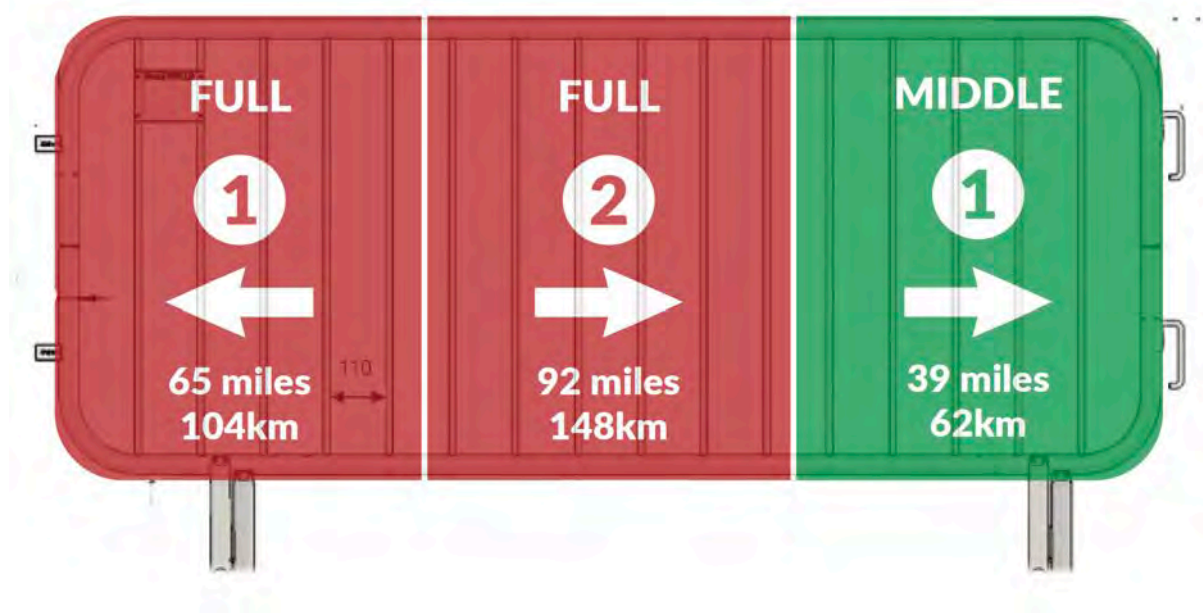

From the course split at Arlington you will head south. Approximately 4km after the course split there is a **tight left bend which tightens unexpectedly**. There will be signs and a marshal at this bend. Please take great care through this bend. No overtaking and no aerobars.

You will cross the A27 at a large roundabout. Please follow the highway code and give way to traffic as necessary. You will be heading towards Alfriston. Just before Alfriston you will turn left towards Littlington. Take care of oncoming vehicles along this section, especially on the narrow bridge just after you turn left.

The next few miles through Littlington and down to Cuckmere is on narrow lanes; there is the potential that you may get slightly held up by oncoming vehicles. Though the village of Littlington **please take extra care and relax and take your time, and don't take any risks**; it's a long day and you will only lose a few seconds.

After Littlington you will emerge onto the main road back to Eastbourne. **This is your first hill of the day!**

Exceat Climb

This climb starts steep for the first 100m. After the first steep section it flattens out for a while before climbing again, but less steep than the first section. This is a busy road, and you will have cars trying to pass you up the hill. Please take extra care if overtaking up this climb.

After this climb you will pass Friston church on your right and then descend steeply into East Dean village. **This is a steep descent; take care! At the bottom of the descent, you will be making a right turn toward Birling Gap.** You will be crossing oncoming traffic and must give way.

Through the village of East Dean, please take care of parked cars on your left and oncoming vehicles. As you pass Birling Gap, be very careful of parked cars and tourists (who have a habit of wandering into the road).

You now have your final climb up and over Beachy Head. **Enjoy the views!**

After Beachy Head you will come to a junction where you will be turning right. Please slow down, observe the highway code and check it is clear to proceed.

100m after this junction you will make a right turn (again across oncoming traffic) to descend the hairpin bends down into Eastbourne. At the bottom of the descent take care on the final left bend as there are a few bumps. **At this point there is zebra crossing and you must stop if pedestrians are crossing.** The final 2 km along the seafront is downhill, but please take care as there will be many pedestrians and vehicles turning and parking in this area.

You will dismount on a downhill section just before the Western Lawns. For those who raced last year, please note this is a new dismount area before the old dismount point so please slow down early and be prepared to stop.



Aquabike Finish

For those competing in the aquabike races, your time will stop at the bike dismount. You must dismount your bike before the dismount line along with everyone else. Once you have dismounted and crossed the dismount line, please proceed into transition, and rack your bike. You can then make your way out of transition through the 'run out' gate and make your way via the run course down to the finish area. You can then walk/run down the finish and cross the finish line for a photo and medal. Remember your time stopped at the dismount line so there's no rush.

Drafting

Drafting, which simply put is taking shelter behind or beside another competitor during the cycling leg of the race, is not allowed. The cycle draft zone will be 12 metres long measured from the leading edge of the front wheel. You may not enter the draft zone of another competitor except for the purpose of overtaking. When overtaking you must be seen to be progressing through that zone. A maximum of 25 seconds is allowed to pass through the draft zone of another competitor. If an overtaking manoeuvre is not completed within 25 seconds the overtaking cyclist must drop back. When a competitor is passed by other competitors, it is his/her responsibility to drop back in order to move out of the draft zone of the overtaking competitor. Failure to do so may result in an official caution or time penalty. A competitor is passed when another competitor's front wheel is ahead of his/her front wheel. Motorcycle and static BTF Referees will patrol the course to enforce the no drafting rule.

Competitors must keep to the left side of the course and not create a blocking incident. Blocking is where a competitor who is behind cannot pass due to the leading competitor being poorly placed on the course.

No Littering

We are fortunate to have a beautiful location here for triathlon. Part of the course is within a National Park. **Dropping litter on any point of the course will result in disqualification.**

Give yourself some extra motivation by raising money for our official charity partner Macmillan and save 50% on your TriBourne entry.

**MACMILLAN
CANCER SUPPORT**

DRAFTING RULES EXPLAINED

All the below are taken from the British Triathlon Competition Rules, available to download from the British Triathlon website.

WHAT IS DRAFTING?

IT'S AGAINST THE RULES

Taking shelter behind another competitor or motor vehicle during the bike phase to gain a competitive advantage.

THE DRAFTING ZONE

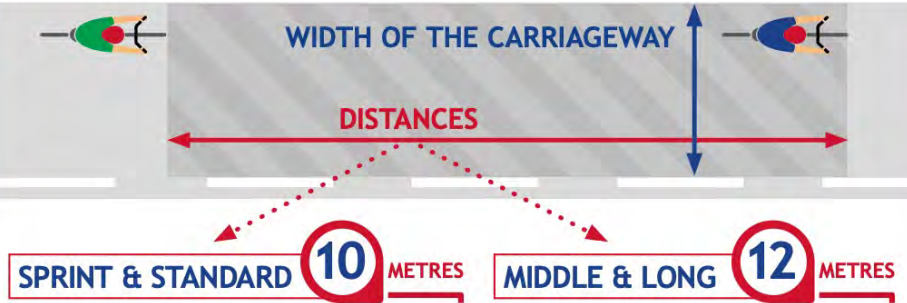

DRAFTING & NOT DRAFTING

✓ NOT DRAFTING



⚠ DRAFTING BIKE



LEAD BIKE



⚠ BLOCKING

You must keep to the left hand side of the course and not block another competitor trying to pass you.

MAKING A PASS

You may enter the draft zone to make a pass within the time allowed.

SPRINT & STANDARD



MIDDLE & LONG



If the pass cannot be made you must drop back.
Any overtaken cyclist must drop back once passed.



OTHER VEHICLES

You must remain **12 metres** behind motorcycles and **35 metres** behind other vehicles to prevent drafting.

PENALTIES

	1st Offence	2nd Offence	3rd Offence
SPRINT	1 MIN PENALTY	DISQUALIFICATION	N/A
STANDARD	2 MINS PENALTY	DISQUALIFICATION	N/A
MIDDLE / LONG	5 MINS PENALTY	5 MINS PENALTY	DISQUALIFICATION



Motorcycle Officials do not have to provide a warning about drafting for safety reasons.

Race Stop Procedure

In the event of a significant incident on the bike course, the following procedures will be followed:

- **YELLOW FLAG** means **CAUTION**. Please slow down.
- **AMBER hazard lights** on motorcycles means **NO OVERTAKING**. Do not pass the motorbike, this will likely be part of a rolling roadblock procedure.
- **RED FLAG** means **STOP**. Stop and wait for further instructions. You may be asked to return to transition or a designated evacuation point depending on the incident.
- **GREEN FLAG** means **GO**. Racing can recommence, this will likely be preceded by a 1-minute verbal warning that racing is about to recommence.

Intentional failure to observe these warnings will result in immediate disqualification.

Transition 2: Bike to Run

Having dismounted your bike before the dismount line, you will run with your bike across the road and through a gap in the hedge onto the Western Lawns.

Run to your position in the transition area and rack your bike. Only after your bike is racked can you remove your helmet. **Do not unclip your helmet until your bike is racked, doing so will result in a penalty.** Remove your helmet and put on your run shoes. Make sure your helmet and any other kit is placed in your box. You will then run out of the transition area onto the run course via the 'Run Out' exit.

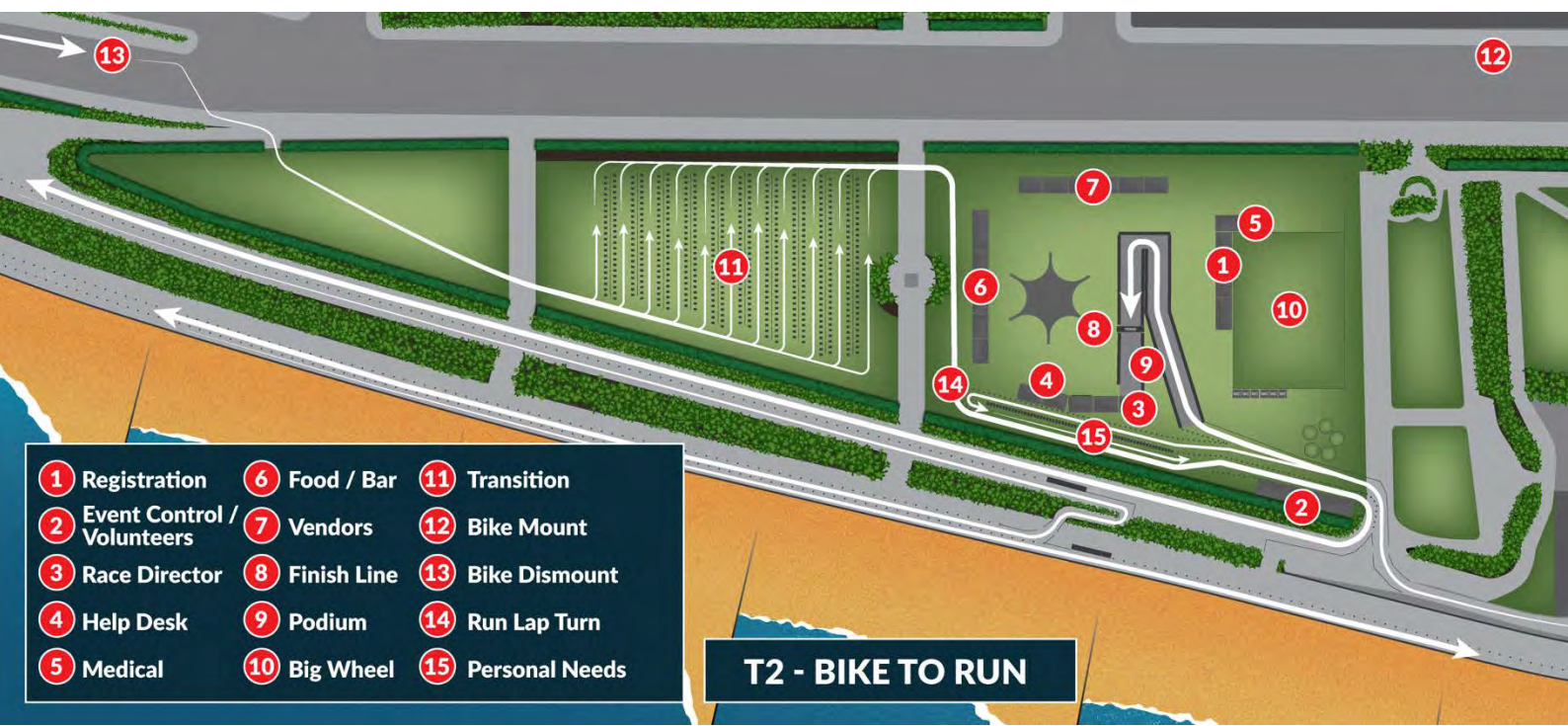

Run

The run course consists of two identical laps each 10.55km. You will start with an out-and-back section to the west along a gravel path. You will then drop down to the lower prom and complete another out-and-back section to the west. You will then complete a longer out-and-back section along the seafront to the east.

On out-and-back sections you will **always pass to the right of oncoming runners**. **Keep to your right and overtake to the left (taking care to avoid oncoming runners)**. As you run west (towards Beachy Head) you will have the public to your right and oncoming runners to your left. As you run east you will keep to the right (again with oncoming runners to your left).

A few short sections are narrow, and you may need to step into the path of oncoming runners to overtake, please take care and wait for a gap to overtake safely.



Run Laps and Finish Split

As you run onto the south-east corner of the Western Lawns you will approach the run lap/finish split. If you still have one more lap to complete, keep left and continue to the right of the personal needs boxes (15) and make a U-turn at the point marked 14 on the map below.

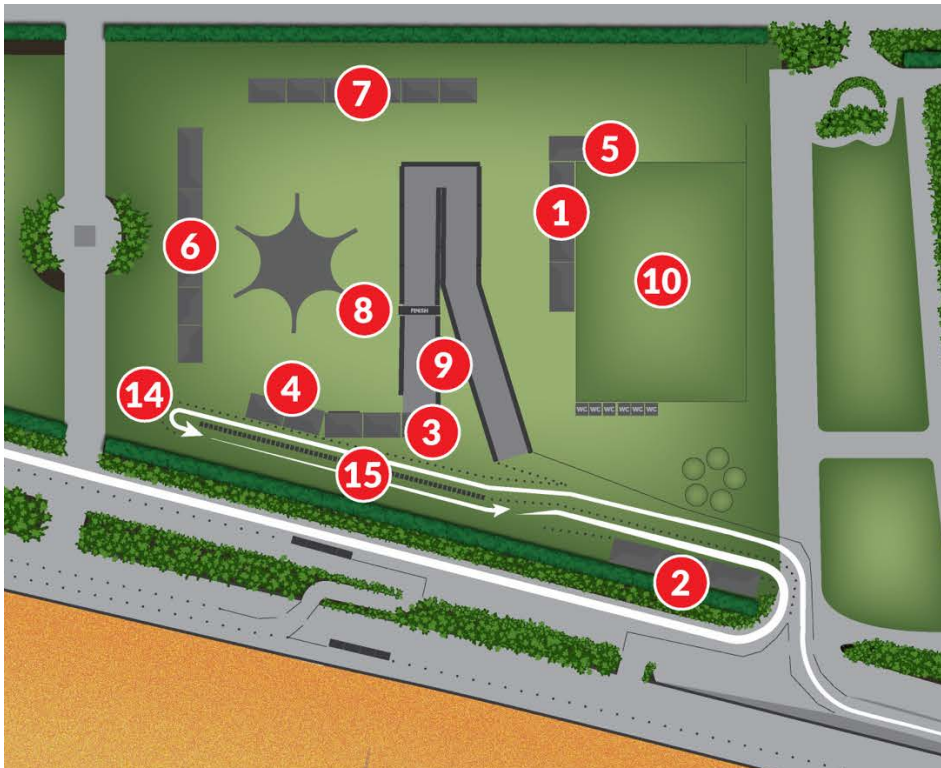

As you run onto the south-east corner of the Western Lawns for the second and final time, keep right and run onto the blue carpet as shown below.

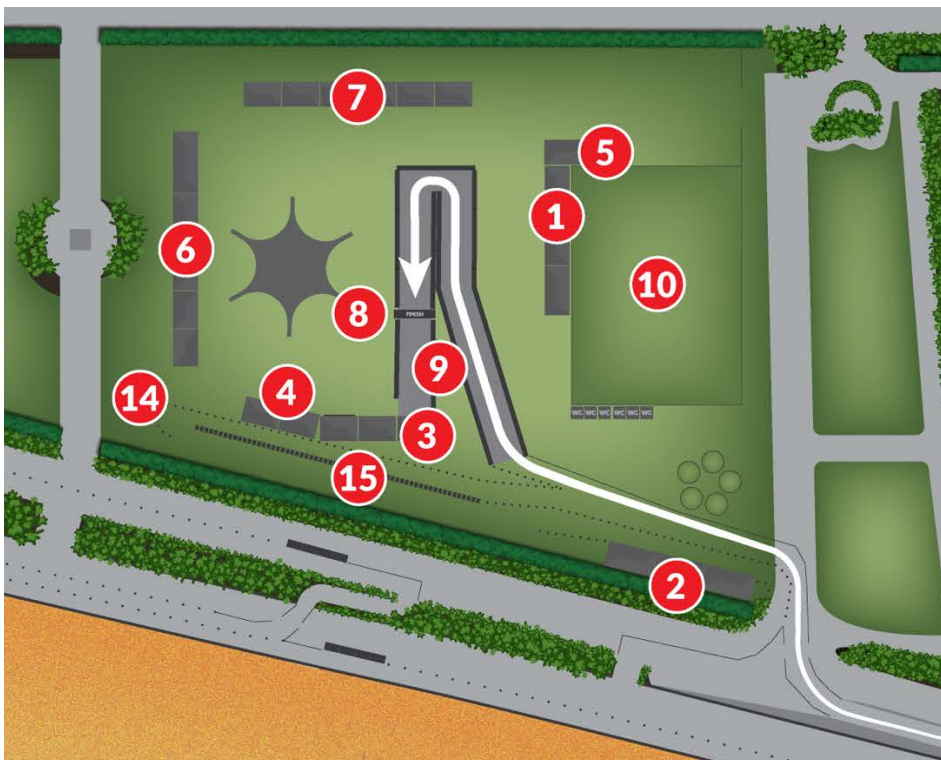

Run Aid Stations

Run aid stations will be located approximately every 2km. As you pass through the aid station you will pass the following:

1. Water (paper cups)
2. High 5 Energy Drink (paper cups)
3. Coke (paper cups)
4. High 5 Gels and Bars
5. Litter drop

No Littering

We are fortunate to have a beautiful location here for triathlon. **Dropping litter on any point of the course other than the designated aid station will result in disqualification.**



SAVOUR
EVERY MILE



Start your training on the right foot with a little help from HIGH5 - our on-course nutrition partner. Use coupon code Tribourne23 to get your exclusive discount on the HIGH5 Cycle Pack to help you be at your best.

Finish and Post Race

Once you have crossed the finish line, you will be presented with your medal. You will then collect your finisher t-shirt by showing your race number and handing in your timing chip at the TriBourne Shop. There will be water and HIGH5 Energy Drink available. Once the last cyclist in your race has finished the bike leg, you will be allowed to return to transition to retrieve your bike and other kit and belongings. **We want to create an amazing atmosphere for our last finishers so please stay around the finish area after your race.**

Post-race massage is available from Sportswise on a donation basis.



BECOME A HOST FAMILY

Post-Race Food and Drinks

For the first time this year we will have a bar and food vendors on site serving alcohol, pizza, fish & chips, ice-cream and more. **Please stay after the race and enjoy a beer or two and food on the Western Lawns.**

Results and Awards

With a time-trial start format, please remember that someone who started behind you could finish behind you and place above you in the results. As you cross the finish line, your name, time, and **current** position will be displayed on the finish gantry. Please remember that your position is not confirmed until the time difference between the first and last starter has elapsed. For example, **the finish line may show you as the winner in your age group, but you may yet be beaten by someone behind you!**



We have awards for the top three open and female in every age-group for the full and middle distance. We also have awards for the top three aquabike finishers, top three swim finishers, top three marathon finishers and the winning relay teams.

Where possible, you should check your finishing position via the live results on our website. If you believe you have finished in the top 3 in your age group, please return to the finish area in time for the awards presentation.

3.8k Swim:

1st, 2nd, and 3rd Open
1st, 2nd, and 3rd Female

Middle Distance Aqua-Bike:

1st 2nd, and 3rd Open
1st 2nd, and 3rd Female
1st 2nd, and 3rd Open 40+
1st 2nd, and 3rd Female 40+

Middle Distance Relay Team:

1st Relay Team

Middle Distance:

1st 2nd, and 3rd Open
1st 2nd, and 3rd Female
Under 20 1st 2nd, and 3rd Open
Under 20 1st, 2nd, and 3rd Female
20 to 24 1st, 2nd, and 3rd Open
20 to 24 1st, 2nd, and 3rd Female
25 to 29 1st, 2nd, and 3rd Open
25 to 29 1st, 2nd, and 3rd Female
30 to 34 1st, 2nd, and 3rd Open
30 to 34 1st, 2nd, and 3rd Female
35 to 39 1st, 2nd, and 3rd Open
35 to 39 1st, 2nd, and 3rd Female
40 to 44 1st, 2nd, and 3rd Open
40 to 44 1st, 2nd, and 3rd Female
45 to 49 1st, 2nd, and 3rd Open
45 to 49 1st, 2nd, and 3rd Female
50 to 54 1st, 2nd, and 3rd Open
50 to 54 1st, 2nd, and 3rd Female
55 to 59 1st, 2nd, and 3rd Open
55 to 59 1st, 2nd, and 3rd Female
60 to 64 1st, 2nd, and 3rd Open
60 to 64 1st, 2nd, and 3rd Female
65 to 69 1st, 2nd, and 3rd Open
65 to 69 1st, 2nd, and 3rd Female
70 to 74 1st, 2nd, and 3rd Open
70 to 74 1st, 2nd, and 3rd Female
75 to 79 1st, 2nd, and 3rd Open
75 to 79 1st, 2nd, and 3rd Female
Over 80 1st, 2nd, and 3rd Open
Over 80 1st, 2nd, and 3rd Female

Full Distance Aqua-Bike:

1st 2nd, and 3rd Open
1st 2nd, and 3rd Female
1st 2nd, and 3rd Open 40+
1st 2nd, and 3rd Female 40+

IronBourne Marathon:

1st 2nd, and 3rd Open
1st 2nd, and 3rd Female
1st 2nd, and 3rd Open 40+
1st 2nd, and 3rd Female 40+

Full Distance Relay Team:

1st Relay Team

Full Distance:

1st, 2nd, and 3rd Open
1st, 2nd, and 3rd Female
Under 20 1st, 2nd, and 3rd Open
Under 20 1st, 2nd, and 3rd Female
20 to 24 1st, 2nd, and 3rd Open
20 to 24 1st, 2nd, and 3rd Female
25 to 29 1st, 2nd, and 3rd Open
25 to 29 1st, 2nd, and 3rd Female
30 to 34 1st, 2nd, and 3rd Open
30 to 34 1st, 2nd, and 3rd Female
35 to 39 1st, 2nd, and 3rd Open
35 to 39 1st, 2nd, and 3rd Female
40 to 44 1st, 2nd, and 3rd Open
40 to 44 1st, 2nd, and 3rd Female
45 to 49 1st, 2nd, and 3rd Open
45 to 49 1st, 2nd, and 3rd Female
50 to 54 1st, 2nd, and 3rd Open
50 to 54 1st, 2nd, and 3rd Female
55 to 59 1st, 2nd, and 3rd Open
55 to 59 1st, 2nd, and 3rd Female
60 to 64 1st, 2nd, and 3rd Open
60 to 64 1st, 2nd, and 3rd Female
65 to 69 1st, 2nd, and 3rd Open
65 to 69 1st, 2nd, and 3rd Female
70 to 74 1st, 2nd, and 3rd Open
70 to 74 1st, 2nd, and 3rd Female
75 to 79 1st, 2nd, and 3rd Open
75 to 79 1st, 2nd, and 3rd Female
Over 80 1st, 2nd, and 3rd Open
Over 80 1st, 2nd, and 3rd Fema

Key Rules

The race is governed by BTF rules and regulations and BTF Technical Officials will be in attendance on race day so please ensure you read and are familiar with them. You can find them on the British Triathlon website: www.britishtriathlon.org

Some key rules to note are:

- Your race numbers must be correctly fixed to your bike, helmet, and clothing or race belt.
- Your handlebars must not have open ends so please obtain bar-end stoppers to plug them before coming to the bike check-in.
- Appropriate racing attire must be worn for the duration of the race.
- No cycling is allowed in the transition area at any time.
- There will be clearly marked mount and dismount lines at 'Bike Mount and 'Bike Dismount'.
- You must secure your helmet strap before removing your bike from the rack and it must not be undone until your bike is replaced on the rack after finishing the cycle section. You will be penalised should you not comply with this rule.
- Athletes must not use any devices which could cause a distraction such as headphones, mobile phones, cameras, etc. during any phase of the race and doing so will result in either a penalty or disqualification. This includes at any time within the transition area before or after the race.
- Nudity is not permitted, including within the transition area. If you want to change, please bring a changing robe.
- There will be BTF Technical Officials in transition to monitor all competitors.
- A bike helmet is compulsory and must be worn during bike check-in.
- Fixed wheel bikes (bikes that use the pedals as a brake) are not permitted in the race. e-bikes are also not permitted.
- Littering during the event is both against the law and unacceptable. **Anyone seen littering during the event will be disqualified.**
- No outside assistance is allowed.
- Cycles and equipment must be placed in the same position at the start and finish of the cycle leg.

Penalties

Any penalties and DQ's will be posted on a notice board located adjacent to the race control tent near the finish line. **Any live results published during the event are provisional only.**

KNOW THE RULES

All the below are taken from the British Triathlon Competition Rules, available to download from the British Triathlon website.

RULE 2.1 Littering



All litter must be placed in bins or elsewhere specified by the Event Organiser – keep hold of it until you can dispose properly.

RULE 2.1 Racing Conduct

Everyone involved in your race is there to ensure you have a safe and enjoyable experience, so we ask that you respect your fellow competitors and treat all Technical Officials, Event Organisers, volunteers and spectators with courtesy. Any abuse towards these people will not be tolerated.

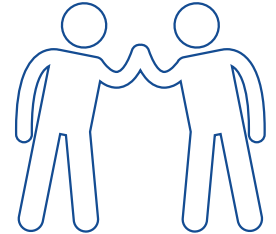

RULE 2.1 Know the Course

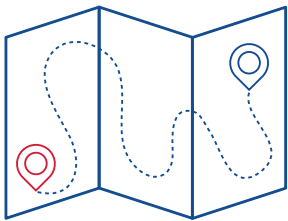

Make sure you know which route to take – check out course maps and if it's unclear, ask the Event Organiser before race day. Marshals are there to ensure the safety of the event, not just to point you in the right direction!

RULE 2.9 Race Numbers

During the cycle stage, race numbers must be visible from the back; during the run stage, race numbers must be visible from the front. Race numbers do not need to be worn during the swim segment. Take care not to fold or damage your number!



RULES 4.10 | 5.2 | 6.4 Illegal Equipment

Certain items are banned during the race – this includes MP3 players, mobile phones and personal video recording devices. Leave these outside transition.



RULE 5.2 Helmets

Helmets must be clipped before the bike is touched, and remain done up until the bike is racked after the cycle stage.

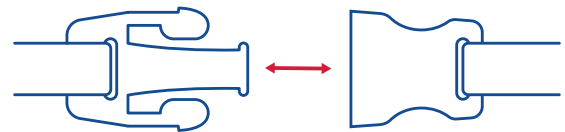

RULE 5.5 Drafting

Competitors must keep their distance from the cyclist in front of them, so as not to gain an advantage.

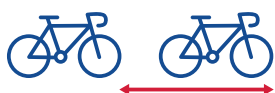

In standard distance and shorter events, the gap between the front wheel of the leading bike, to the front wheel of the following bike should be 10 metres – if overtaking a competitor, you have 20 seconds to pass through their draft zone.

In middle and long distance events, the gap is 12 metres and the time allowed to pass through is 25 seconds.

RULE 7.1 Transition

Competitors should only bring into transition what is needed – a small bag can remain but large, bulky boxes are to be taken out of transition whilst the race is live.

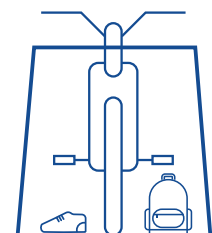

Medical Considerations

Our event medical team, East Sussex Medical Event Services will be on standby for any first aid or medical treatment. Their main treatment facility will be located near the finish line and medical teams will be stationed or mobile at various places on the course.

Medical Advice - You should discuss any medical problems with your GP before competing in the triathlon. This advice is in addition to anything he or she says. If you have a medical condition, put a cross on the front of your race number.

Cardiac Assessment and Screening - If you have a family history of heart disease or sudden death or you have any symptoms of possible heart disease, i.e. chest pain during exercise, sudden shortness of breath, or rapid palpitations, you should see your GP who can arrange for you to have a proper cardiac assessment.

On the Day - Do not compete if you feel unwell or have recently been unwell. This advice applies even if you are raising money for charity. If you feel feverish, have had diarrhoea or been vomiting or had any chest pains **DO NOT RACE!** Many medical emergencies occur because people who have been unwell but do not want to miss the event

Hydration - Drinking a sensible fluid intake is necessary for a triathlon. Your thirst is the best and safest guide to how much to drink during the event. You should start the race adequately hydrated and then drink small amounts as your thirst dictates. Avoid drinking too much fluid before, during or after the race, as it is possible to get ill from drinking too much fluid (this applies to water or sports drinks).

FAQs

Are there changing facilities & showers?

There are no changing facilities. We recommend you arrive ready to race and bring some warm clothes for afterwards. There are a limited number of public showers on the beach.

What do we do with lost property?

Please hand any items found to the help desk. We will hold onto any lost property for one month after the race. If you have lost an item of your property, please email us at office@tribourne.co.uk

Can I buy photographs?

Finish line photographs will be available to purchase directly from our official photographers. A link will be emailed to all participants after the race.

Are there any age restrictions to the event?

You must be 15 on or before 31st December 2022 for the sprint distance and 17 on or before 31st December 2022 for the standard distance.

I have a disability; can I still participate?

We are an inclusive event and do our utmost to accommodate participants with disabilities. Please contact us at office@tribourne.co.uk with a description of your disability. We will assess this and establish if it is possible to compete and what we require to make this feasible.

What is the British Triathlon Federation (BTF) day membership for?

The BTF day license is a license for racing and covers your public liability insurance for the day. For further information on race licenses please contact the BTF directly www.britishtriathlon.org.

I am unable to race; can I have a refund or transfer my place to next year?

Unfortunately, due to our very tight budget and the impact that deferrals would have on our financial position next year, we can't offer a refund or deferral within the last 4 weeks before the race.

Can I use tribars on my bike?

Yes, tribars are allowed. Tribars and handlebar ends must be plugged, and they must be secure. Unlike draft legal races, there is no requirement for them to be shorter than the brake levers.

Is the race draft legal?

No. Drafting is against the rules. See the drafting section earlier in this document.

How can I find out my finish time?

Results will be posted on our website following the race at www.140.6miles.co.uk

I still have my timing chip; how do I return it?

Please post your timing chip back to us at: TriBourne Multisport Events Ltd., 37 Hill Road, Eastbourne, BN20 8SN. If we do not receive this, you will be liable for the £40 cost of the chip.

Do you need volunteers?

We need lots of volunteers to help make this a great event. If any of your friends or family are interested in being part of this major sporting event, please ask them to email volunteers@tribourne.co.uk. Each volunteer will receive a hot meal, hot drinks, water bottle, t-shirt and £25 credit for each 4 hour shift.

Are there any toilets?

Yes, there will be toilets within transition on the Western Lawns.

Are drinks provided?

Yes, there will be an aid station on the run and at the finish line.

What are the rules?

The race is governed by BTF rules and regulations and BTF Technical Officials will be in attendance on race day so please ensure you read and ensure you are familiar with them. You can find them on the British Triathlon website: www.britishtriathlon.org

Who are we?

We are Mat Dowle and Dale Anderton, both experienced triathletes living in Eastbourne. We have set up TriBourne Multisport Event Ltd to facilitate the delivery of the Multisport events in Eastbourne which now includes the Eastbourne Triathlon, IronBourne and Brighton & Hove Triathlon. Between us we have many hundreds of hours of racing experience at all levels and over all distances. We have experienced everything that is both good and bad about racing triathlon, and this experience puts us in a great position to deliver the best possible, athlete focussed race experience.

Mat Dowle came to triathlon relatively late in life, completing his first triathlon in 2006 at the age of 29. Since then, he has completed over 20 Ironman distance races and countless shorter distance events.

"I started running in my 20's and completed many marathons and ultra-distance running events. After 10 years of running, I needed a new challenge and entered my first triathlon (Ironman France). At that time, I had never learned to swim, so the build up to that first Ironman was a steep learning curve. I conquered the swim, mountains, and the heat of the run, ending up with a decent result... I loved the experience and there was no going back!"



"Over the past 20 years I've completed many triathlons over all distances from sprint to Ironman. I've picked up some good results over the years and I've been on the GB Age Group Team at several World and European Championship events."

"I'm a perfectionist and I hope my commitment and attention to detail will result in an outstanding race experience for everyone involved."



Dale Anderton has been involved in triathlon and endurance sports for over 40 years.

"I fell in love with triathlon and the endurance way of life in the 1980's whilst serving as a Royal Marine and doing my first sprint distance event. Since then, I have competed in 100's of races across the globe at all distances including the Ironman World Championships in Kona, Hawaii; an experience I will never forget."

"I moved to Eastbourne to study a Sports Science Degree in 1994 and now I wouldn't want to live anywhere else. I train with many great local clubs such as Meads Runners, Team Bodyworks and Run Wednesdays and see this event as a way of giving something back to the community and sport that has given me so much over the years."

"Our aim is to provide everyone the best experience possible, whether you're an international professional athlete or if this is your first multisport event."

Our Sponsors and Partners

The Eastbourne Triathlon would not be possible without the generous support of our headline sponsor Eastbourne College and many other partners.

TRI
WETSUIT
HIRE



Vitx | cycle

KITBRIK

ZONE3 



°CRYOBRIGHT

Sportswise
excellence in Sports Medicine



**MEADS
RUNNERS**

CYCLESHACK



TeamBodyworks
Performance Triathlon

runnersneed
the running specialists

hotpod yoga

T:EMPO

**MACMILLAN
CANCER SUPPORT**



Choice
VEHICLE RENTALS



TRAIN | RECOVER |



°CRYOBRIGHT

**#RECOVER
#LIKEAPRO**

YOUR DESTINATION FOR:

- **OPTIMISED HEALTH**
- **ENHANCED WELLNESS**
- **ADVANCED RECOVERY**

EXPERIENCE CUTTING-EDGE WELLNESS & RECOVERY TECHNOLOGY + EXPERTLY DELIVERED HANDS ON THERAPIES TO HELP YOU FEEL BRIGHTER INSIDE & OUT

£15
VOUCHER



SCAN WITH PHONE CAMERA
TO CLAIM YOUR £15 VOUCHER

T&C's APPLY

🌐 [Cryobright.co.uk](https://cryobright.co.uk) 📞 01273 777474 📷 @cryobright

**FOR APPTS
CALL OR
BOOK ONLINE**

TRAIN. RECOVER. REPEAT.



OUR SERVICES CAN HELP:

DECREASE SWELLING & INFLAMMATION | BOOST ENERGY
DIAGNOSE & TREAT INJURY | REDUCE PAIN & MUSCLE SORENESS
MAINTAIN JOINT HEALTH | IMPROVE MOBILITY & FLEXIBILITY
REDUCE RISK OF INJURY | PROMOTE SLEEP | RELIEVE STRESS
SPEED RECOVERY FROM TRAINING OR COMPETITION

01273 777474

HELLO@CRYOBRIGHT.CO.UK

197-199 CHURCH ROAD, HOVE, BN3 2AB